

MAURY HIGH SCHOOL STUDY GUIDE



Name: _____

ORDERS OF THE SENTRY

1. To take charge of this post and all government property in view.
2. To walk my post in a military manner, keeping always on the alert, and observing everything that takes place within sight or hearing.
3. To report all violations of orders I am instructed to enforce.
4. To repeat all calls from posts more distant from the guard house than my own.
5. To quit my post only when properly relieved.
6. To receive, obey, and pass on to the sentry who relieves me, all orders from the Commanding Officer, Command Duty Officer, Officer of the Deck, and Officers and Petty Officers of the watch only.
7. To talk to no one except in the line of duty.
8. To give the alarm in case of fire or disorder.
9. To call the Officer of the Deck in any case not covered by instructions.
10. To salute all officers, and colors and standards, not cased.
11. To be especially watchful at night, and during the time for challenging, to challenge all persons on or near my post, and to allow no one to pass without proper authority.

(When given a question cadets will answer with “maam/sir/petty officer/chief...etc”, this cadets fourth order to the sentry is to repeat all calls from posts more distant from the guard house than my own, mam/sir/petty officer/chief...etc”)

National Chain of Command

President of the United States – Joseph Biden

Vice President of the United States – Kamala Harris

Secretary of Defense – Lloyd Austin

Secretary of the Navy – Carlos Del Toro

Secretary of State – Anthony Blinken

Chairman of the Joint Chiefs of Staff – General Charles Q. Brown

Vice Chief of Naval Operations – Admiral Lisa Franchetti

Assistant Commandant of the Marine Corps – General Eric M. Smith

Master Chief Petty Officer of the Navy – MCPON James Honea

Sergeant Major of the Marine Corps – Sergeant Major Carlos A. Ruiz

Commander, Naval Education and Training Command – Rear Admiral Jeffrey Czerewko

Commander, Naval Service Training Command – Captain Craig Mattingly

NJROTC Director- Mr. Bruce Nolan

Area 5 Manager- Mr. James Landis

Senior Naval Science Instructor – CWO4 E. Brinson

Naval Science Instructor- SCPO W. Bolden

MHS Principal- Ms. Karen Berg

(When asked “who is the secretary of defense?” cadets will reply with “sir or Ma’am, secretary of defense is the Mr. Loyd Autin, sir or Ma’am”)

NJROTC STAFF CHAIN OF COMMAND

- Commanding Officer – Cadet LT Commander Colastre, RI
- Executive Officer – C/Lieutenant Sama
- Senior Enlisted Advisor- C/MCPO Malik
- LT of Drill Commander- C/ MCPO Malik
- Drill Commander- C/PO2 Suleiman
- Operations Officer – C/PO2 Colastre RE
- Academic Officer-C/PO2 Seligman
- Admin Officer-C/ENS Priest
- Supply Officer – C/ LTJG Jimnez
- Color Guard Commander- C/PO2 Glasgow
- Physical Training-C/PO1 Lindsey
- Drone Officer-C/PO2 Quick
- Cyber Patriot- C/ LTJG Jimnez
- Air Rifle- C/PO2 Quick
- Armory- C/ PO1 Davidson
- PAO- C/ PO2 Kenny and PO3 White

MILITARY RANKS

NAVY ENLISTED RANKS

E-1: Seaman Recruit (SR)

E-2: Seaman Apprentice (SA) 

E-3: Seaman (SN) 

E-4: Petty Officer 3rd Class (PO3) 

E-5: Petty Officer 2nd Class (PO2) 

E-6: Petty Officer 1st Class (PO1) 

E-7: Chief Petty Officer (CPO) 

E-8: Senior Chief Petty Officer (SCPO) 

E-9: Master Chief Petty Officer (MCPO) 

E-9*: Master Chief Petty Officer of The Navy (MCPON): MCPO Honea
*“E-9 special “When asked “what is an e-9 special?” cadets will reply with “Sir an E-9 special is a Master Chief Petty Officer of the Navy, the current Master Chief Petty Officer of the navy is Master Chief Petty Officer Honea”

NAVY OFFICER RANKS

O-1: Ensign (ENS) 

O-2: Lieutenant Junior Grade (LTJG) 

O-3: Lieutenant (LT) 

O-4: Lieutenant Commander (LCDR) 

O-5: Commander (CDR) 

O-6: Captain (CAPT) 

O-7: Rear Admiral Lower Half (RADM (L)) 

O-8: Rear Admiral Upper Half (RADM (U)) 

O-9: Vice Admiral (VADM) 

O-10: Admiral (ADM) 

O-11/O10*: Fleet Admiral (Used only during times of war)





ENLISTED MARINE RANKS:

E-1: Private

E-2: Private First Class (PFC) [collar insignia: 



E-3: Lance Corporal (LCPL) [collar insignia: 



E-4: Corporal (CPL) [collar insignia: 

E-5: Sergeant (SGT) [collar insignia: 

E-6: Staff Sergeant (SSGT) [collar insignia: 

E-7: Gunnery Sergeant (GYSGT) [collar insignia: 

E-8: Master Sergeant (SGTMAJ) / First Sergeant (1stSGT) [collar insignia:  / 

E-9: Sergeant Major (SGTMAJ) / Master Gunnery Sergeant (MGYSGT) [collar insignia:  / 

E-9*: Sergeant Major of The Marine Corps- Sergeant Major Green

MARINES OFFICER RANKS

O-1: 2ND Lieutenant (2nd LT) [collar insignia: 

O-2: 1st Lieutenant (1st LT) [collar insignia: 

O-3: Captain (CAPT) [collar insignia: 

O-4: Major (MAJ) [collar insignia: 

O-5: Lieutenant Colonel (LTCOL) [collar insignia: 

O-6: Colonel (COL) [collar insignia: 

O-7: Brigadier General (BGEN) [collar insignia: 

O-8: Major General (MAJGEN) [collar insignia: 

O-9: Lieutenant General (LTGEN) [collar insignia: 

O-10: General (GEN) [collar insignia: 

CADETS CREED

- I AM A NAVY JUNIOR ROTC CADET
- I STRIVE TO PROMOTE PATRIOTISM AND TO BECOME AN INFORMED AND RESPONSIBLE CITIZEN
- I RESPECT THOSE IN POSITIONS OF AUTHORITY
- I SUPPORT THOSE WHO HAVE DEFENDED FREEDOM AND DEMOCRACY AROUND THE WORLD
- I PROUDLY EMBRACE THE NAVY'S CORE VALUES OF HONOR, COURAGE, AND COMMITMENT
- I AM COMMITTED TO EXCELLENCE AND THE FAIR TREATMENT OF ALL

Knowledge

Birthday of the Navy- October 13, 1775

Birthday of the Marine Corps- November 10, 1775

Navy anthem- Anchors Away

Marine Corps anthem- The Marine Corps Hymn

The drill rifle we use- 1903 Springfield Rifle "Daisy."

N.J.R.O.T.C? - Navy Junior Reserve Officer Training Corp

1st ship commissioned in U.S. Navy- USS Constitution (a frigate), October 1st, 1797.

NJROTC was created when? Why? - 1964; as part of the ROTC vitalization act

PHONETIC ALPHABET

A-ALFA

W-WHISKEY

B- BRAVO

X-X-RAY

C- CHARLIE

Y-YANKEE

D- DELTA

Z-ZULU

E- ECHO

F- FOXTROT

G- GOLF

H- HOTEL

I- INDIA

J- JULIET

K- KILO

L- LIMA

M- MIKE

N- NOVEMBER

O- OSCAR

P- PAPA

Q- QUEBEC

R- ROMEO

S-SIERRA

T- TANGO

U-UNIFORM

V- VICTOR

Terminology

Head-Bathroom

Cover-Hat

Deck-Floor

Bulkhead-Wall

Overhead-Ceiling

Port-Left

Starboard-Right

Bow-Front

Stern-Rear

Galley-Kitchen

Mess Hall (Mess Decks)-Dinning Facility

Berthing-Living Quarters

Rack-Bed

Sea Bag-Luggage used for travel.

Scuttlebutt-Water Fountain (could also mean gossip)

PDA-Public Display of affection

PT-Physical Training

Quarter Deck-Special area on board the ship for ceremonies and where the officer of the day stands watch.

Muster-Taking attendance

CO-Commanding officer

XO-Executive Officer

Adrift-Loose from towing or moorings, scattered about, not in proper stowage.

Aft Referring to or near the stern (rear) of a vessel

All hands-All members of a command

As you were-Resume former duty

Aye, aye, sir-Acknowledge of an order meaning I understand, I will carry out the order.

Gangway- Command announcement to stand aside to let an officer through.

Make a hole-A command to stand aside, used for a shipmate.

Geedunk-The place (aboard ship) where candy, ice cream, and soda can be purchased.

Ladder-Stairs

Swab-A mop

Military Time

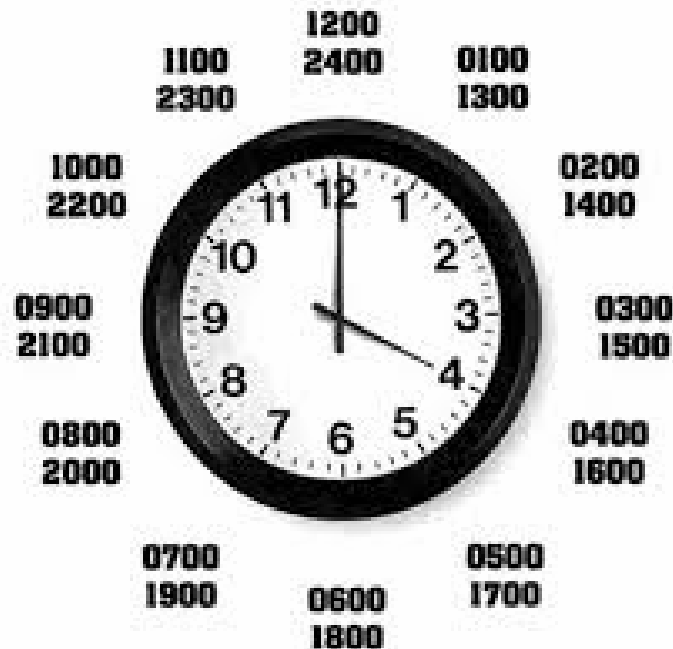

NORMAL TIME	MILITARY TIME	NORMAL TIME	MILITARY TIME
12:00 AM	0000	12:00 PM	1200
1:00 AM	0100	1:00 PM	1300
2:00 AM	0200	2:00 PM	1400
3:00 AM	0300	3:00 PM	1500
4:00 AM	0400	4:00 PM	1600
5:00 AM	0500	5:00 PM	1700
6:00 AM	0600	6:00 PM	1800
7:00 AM	0700	7:00 PM	1900
8:00 AM	0800	8:00 PM	2000
9:00 AM	0900	9:00 PM	2100
10:00 AM	1000	10:00 PM	2200
11:00 AM	1100	11:00 PM	2300

WHAT IS MILITARY TIME?



24 HOUR TIME FORMAT

Uses the 24 hour format to eliminate the need for "a.m." and "p.m." designations.

24 HOUR DAYS

The day starts and ends at 24 hours making it impossible to confuse time.



MILITARY TIME USE

Military time is used by the military, civilian pilots, law enforcement, firefighters, emergency personnel, and hospitals.

WHAT IS 12:00 A.M.?

12:00 a.m. is referred to as either 0000 or 2400 hours. Clocks and watches that can display military time show 12:00 a.m. as 0000.





INTERNATIONAL NAVAL SIGNAL FLAGS



A: ALPHA
Diver Down
Keep Clear



B: BRAVO
Dangerous
Cargo



C: CHARLIE
Yes



D: DELTA
Keep Clear



E: ECHO
Altering Course
to Starboard



F: FOXTROT
Disable



G: GOLF
Diver Down
Keep Clear



H: HOTEL
Pilot on Board



I: INDIA
Altering Course
to Port



J: JULIET
On Fire Keep Clear



K: KILO
Desire to
Communicate



L: LIMA
Stop
Instantly



M: MIKE
I Am
Stopped



N: NOVEMBER
No



O: OSCAR
Man Overboard



P: PAPA
About to Sail

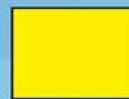

Q: QUEBEC
Request Pratique



R: ROMEO



S: SIERRA
Engines Going
Astern



T: TANGO
Keep Clear



U: UNIFORM
Standing Into
Danger



V: VICTOR
Required
Assistance



W: WHISKEY
Require Medical
Assistance



X: XRAY
Stop Your
Intention



Y: YANKEE
Am Dragging
Anchor



Z: ZULU
Require A Tug



0: ZERO



1: ONE



2: TWO

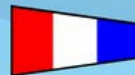

3: THREE



4: FOUR

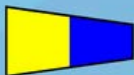

5: FIVE



6: SIX



7: SEVEN



8: EIGHT



9: NINE

Hand Salute

The Salute

- U.S. Navy carried tradition over from Royal Navy--juniors uncovered to address seniors--was shortened to the salute as it is known today
- Significance of salute today
 - ✓ Time-honored tradition of courtesy among military personnel
 - ✓ Expression of mutual pride and respect



NJROTC Male Uniform

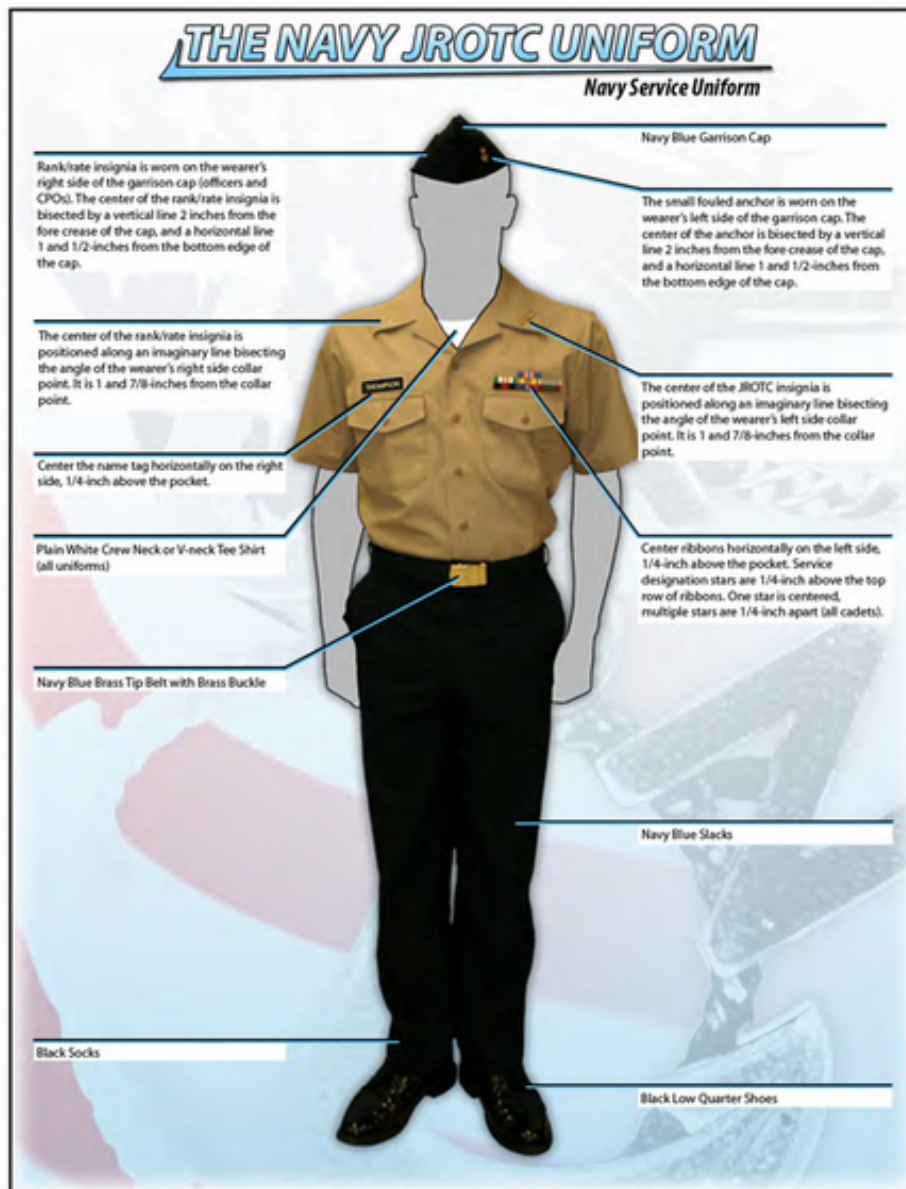

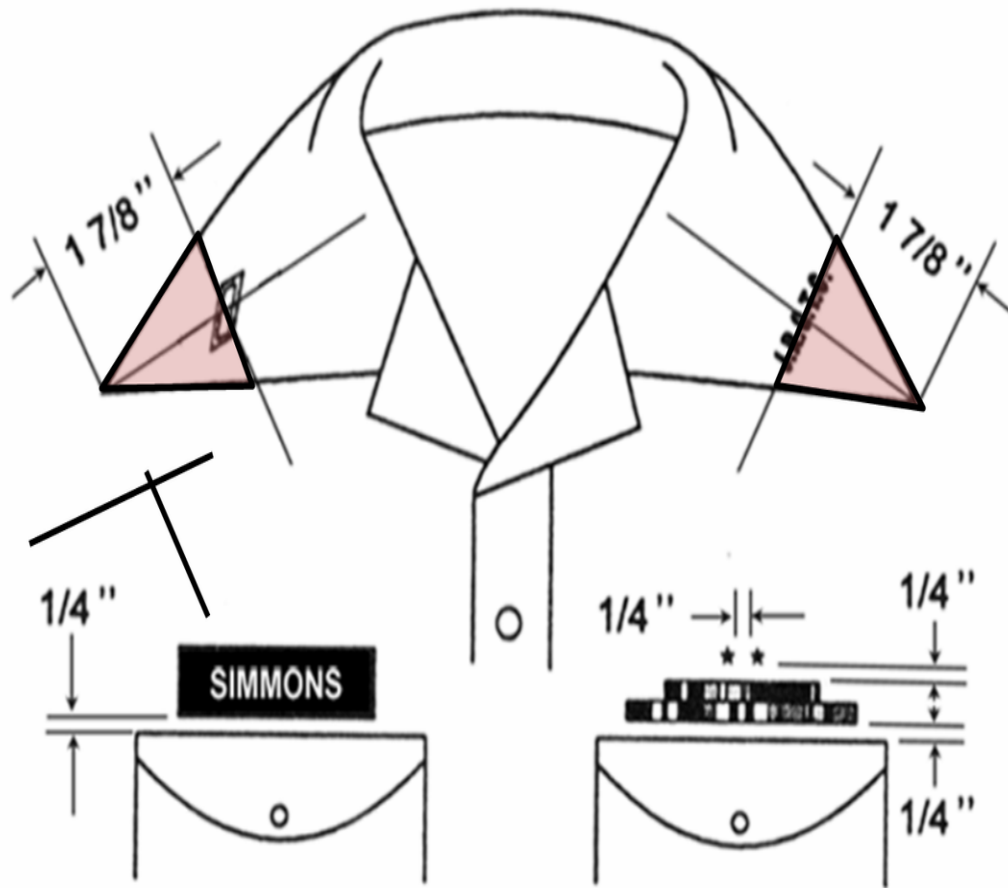

THE NAVY JROTC UNIFORM

Service Dress Blue Uniform

The center of the rank/rate insignia is positioned on the wearer's right side collar 1/2-inch above the notch in the lapel. The vertical axis is parallel to, and centered between, the outer edges of the coat collar (male cadet officers/CPOs).

Only the Leadership Academy aiguillette will be worn on the right shoulder. No more than one aiguillette may be worn on each shoulder.

Black Necktie

Navy Blue Slacks

Black oxford shoes are authorized for wear (male cadets).

The large fouled anchor is worn on the combination cap.

The center of the JROTC insignia is positioned on the wearer's left side collar 1/2-inch above the notch in the lapel. The vertical axis is parallel to, and centered between, the outer edges of the coat collar (male cadet officers/CPOs).

The NJROTC patch is worn on the left sleeve.

Center ribbons horizontally on the left side, 1/4-inch above the coat pocket. Service designation stars are 1/4-inch above the top row of ribbons. One star is centered, multiple stars are 1/4-inch apart (all cadets).

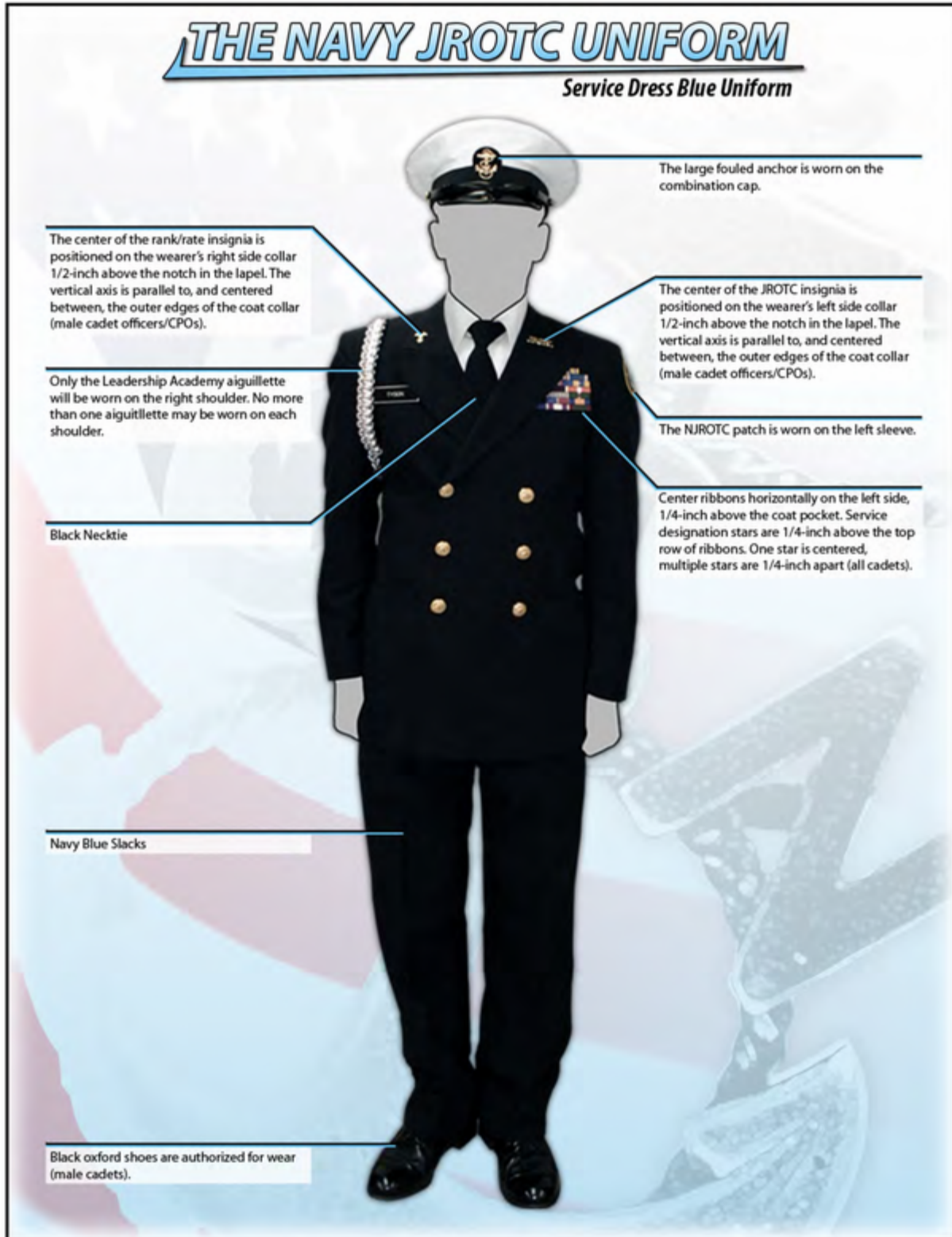

NJROTC Feale Uniform

THE NAVY JROTC UNIFORM
Navy Service Uniform

Navy Blue Garrison Cap

Rank/rate insignia is worn on the wearer's right side of the garrison cap (officers and CPOs). The center of the rank/rate insignia is bisected by a vertical line 2 inches from the fore crease of the cap, and a horizontal line 1 and 1/2 inches from the bottom edge of the cap.

The small fouled anchor is worn on the wearer's left side of the garrison cap. The center of the anchor is bisected by a vertical line 2 inches from the fore crease of the cap, and a horizontal line 1 and 1/2 inches from the bottom edge of the cap.

The center of the rank/rate insignia is positioned along an imaginary line bisecting the angle of the wearer's right side collar point. It is 1 and 7/8 inches from the collar point.

The center of the JROTC insignia is positioned along an imaginary line bisecting the angle of the wearer's left side collar point. It is 1 and 7/8 inches from the collar point.

Center the name tag horizontally over the front seam on the right side, 6 1/4 inches down from the intersection of the front and shoulder seams.

Khaki Long or Short Sleeve Shirt

Plain White Crew Neck or V-neck Tee Shirt (all uniforms)

Center ribbons horizontally over the front seam on the left side, 6 1/4 inches down from the intersection of the front and shoulder seams. Service designation stars are 1/4-inch above the top row of ribbons. One star is centered, multiple stars are 1/4-inch apart (all cadets).

Navy Blue Slacks

Black Socks

Black Low Quarter Shoes or Pumps

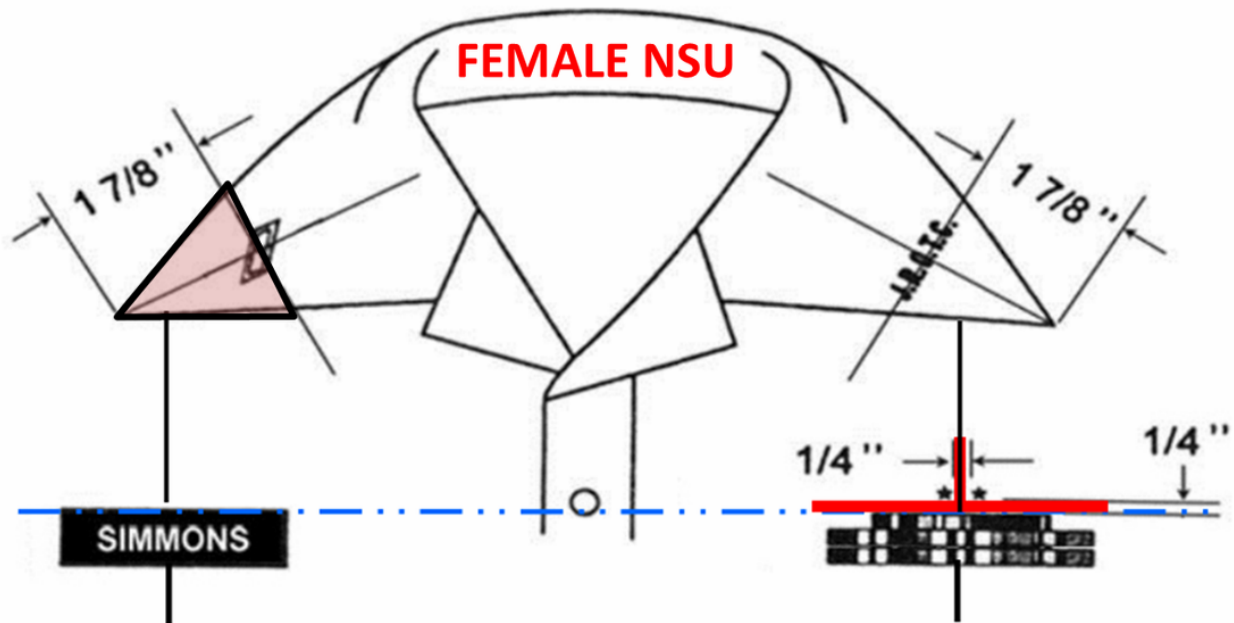

- Nametag Top aligned w/ Top Button - Centered on Seam
- Up to 3 Rows of Ribbons aligned w/ Top Button Centered on Seam – *Additional Ribbons work upward*
- Year Stars $\frac{1}{4}$ Inch Above Ribbons

THE NAVY JROTC UNIFORM

Service Dress Blue Uniform

The rank/rate insignia is positioned on the wearer's right side on the rounded end of the coat collar with the vertical axis of the insignia parallel to, and centered between, the outer rounded edges of the collar (female cadet officers/CPOs).

Only the Leadership Academy aiguillette will be worn on the right shoulder. No more than one aiguillette may be worn on each shoulder.

Black Neck Tab

Navy Blue Skirt

Nylon hosiery similar in color to skin tone

The large fouled anchor is worn on the combination cap.

The JROTC insignia is positioned on the wearer's left side on the rounded end of the coat collar with the vertical axis of the insignia parallel to, and centered between, the outer rounded edges of the collar (female cadet officers/CPOs).

The NJROTC patch is worn on the left sleeve.

Center ribbons horizontally on the left side, 1/4-inch above the coat pocket. Service designation stars are 1/4-inch above the top row of ribbons. One star is centered, multiple stars are 1/4-inch apart (all cadets).

Black oxford shoes or service pumps may be worn. The pump will be plain, with closed toe and heel. The sole will be no thicker than 1/4-inch. The heel will be between 5/8-inch and 2 and 5/8-inches high, and no wider than 1 and 3/4-inches at the base (all female cadets).

